

MUJI 無印良品

ULTRASONIC AROMA DIFFUSER HAD-001-GLW-AU

User Manual

Thank you for purchasing this product.

For your safety and enjoyment, please read and understand this manual before using your product.

After reading this manual, store in a safe and handy location for future reference regarding any questions that may arise.

Version 3.0
2019.11

Table of Contents

• Introduction	1-5
• About Essential Oils	6
• Enjoying Your Aroma Diffuser	6
• Components	7
• Part Names	8
• Using Your Aroma Diffuser	9-13
• Cleaning up Spills	14-15
• Care and Storage	16-18
• Disposal	19
• Troubleshooting	19-20
• Specifications	21
• Quick Start Guide	23





Introduction

For your safety, please read and follow all instructions.

- This product is a household electrical appliance.
- This product is not intended for use as interior room lighting.
- This product can be used by children aged from 8 years and above and persons with reduced physical, sensory or mental capabilities or lack of experience and knowledge if they have been given supervision or instruction concerning use of the appliance in a safe way and understand the hazards involved.

This User Manual includes symbols and icons to warn the user and prevent potential risks that may result from improper usage of this product. These symbols and marks have the following meanings.

Mark/Symbol Meaning

 Caution	 This symbol indicates a matter requiring user caution.
 Prohibited Action	 This symbol indicates a prohibited action.
 Warning	This symbol indicates a matter which, if ignored, may lead to major injury or death in the event of the improper usage of this product.

Before Using This Product

 Do Not Modify	Do not attempt to modify this product. Do not allow anyone other than a qualified service technician to disassemble or repair this product. → Attempting to modify this product may lead to fire, electrical shock, injury, or product malfunction.
 Prohibited	Never attempt to insert pins, wires, or other foreign objects into the mist diffuser outlet or seams/gaps in the product. → Doing so may lead to electrical shock or injury.
 Prohibited	Children shall not play with the appliance.

-1-

 Prohibited
Do not use this product if the AC adapter power cord or plug become damaged, or if the plug does not sit firmly in the electrical outlet socket.
→ Doing so may result in electrical shock, short circuit, or fire.

 Wet Hands Prohibited
Do not attempt to insert/remove the AC adapter with wet hands.
→ Doing so may lead to electrical shock or injury.

 Wet Use Prohibited
Do not submerge or pour/splash water on this product or its AC adapter. Do not use or store in locations subject to high humidity such as bathrooms, changing rooms, green houses, etc.
→ Doing so may result in short circuits, electrical shock, fire, or product malfunction.

 Prohibited
Never touch the ultrasonic diaphragm in this product.
→ Never directly touch, damage, or push on the ultrasonic diaphragm. Doing so may cause an accident or malfunction.

 Prohibited
Do not damage the AC adapter power cord, bend the cord forcefully, pull, or twist the cord. Do not allow the cord to come close to hot components, and do not set heavy items on top of the AC adapter cord. Do not pinch the cord between other objects or attempt to modify the cord in any way.
→ Doing so may result in damage to the cord, fire, or electrical shock.

 Prohibited
Do not install or use within the reach of infants or pets.
→ Doing so may result in the product tipping over or in other accidents such as electrical shock or injury.

 Required
Replace water in the water tank with clean tap water on a daily basis. Periodically clean the water tank, and always keep the water tank in a clean condition.
→ Failure to do so may result in the growth of bacteria or mould, or may result in bad odours or other conditions that may be harmful to your health. In rare cases, mould or bacteria could lead to hypersensitive reactions such as allergy, depending on the condition of the person or pet in question.

-2-

Using This Product

 Unplugging the Cord
Immediately unplug the AC adapter from the electrical outlet if you notice an abnormal odour, abnormal sound, if the adapter or diffuser unit becomes unusually hot, or if you notice some other abnormal behaviours.
→ Continuing to use this product despite abnormal operations may result in fire, electrical shock or other injury, or malfunction. When noticing abnormal operation of your product, immediately stop using the product and consult store you purchased the product.

After Use

 Prohibited
Cleaning and user maintenance shall not be made by children without supervision.

 Unplugging the Cord
Unplug the AC adapter from the electrical outlet when not in use.
→ Insulation deterioration may result in short-circuit fire or electrical shock.

 Prohibited
Only use a neutral detergent when caring for this product.
→ Failure to do so may result in detergent remaining inside the water tank, causing toxic gas or product malfunction.

 Prohibited
This device is not a medical inhaler or vaporizer. Do not intentionally inhale mist emitted from the diffuser outlet directly.
→ Doing so may be a hazard to your health. Do not use this product for any other purpose than to emit and diffuse aroma.



 Required
Periodically dust off the power plug.
→ Dust build up can result in insulation failure due to humidity, fire, electrical shock, or product malfunction.

 Required
Perform care and drain water from the product by following the correct directions and methods described in this User Manual.
→ If drained in an incorrect direction, water may enter electrical components, which may result in fire, electrical shock or short circuits.

-3-

Caution	This indicates a matter which may lead to user injury or physical property damage.
----------------	---

Before Using This Product

- Required**  **Always use clean, room-temperature tap water.**
→ Using warm/hot water may result in warping or product malfunction.
- Required**  **When not using the product for a period of time, follow the procedures as detailed under Care/Storage before resuming usage.**

- Prohibited**  **Do not use this product in the following locations.**
→ Doing so may result in product breakdown, malfunction, or damage to surrounding areas.
 - Do not place in a location that allows mist emitted from the product to come into direct contact with furniture, clothing, curtains, walls, documents or other paper goods, ceiling, etc.
 - Do not place in a location under direct sunlight, locations subject to extreme heat such as heaters or sources of flame, or locations subject to direct wind such as near air conditioners.
 - Do not place near other household appliances, near precision equipment, on soft cushions, or on pile/thick carpet.
 - Do not place on unstable/non-flat surfaces.

Using This Product

- Required**  **Always hold this the diffuser unit by its lower section when lifting it to move.**
→ Failure to do so may result in the diffuser unit falling or tipping over, since the outer cover is not securely attached.

- Heat Caution**  **Do not touch the diffuser unit while it is in operation or immediately after turning it off.**
→ The diffuser unit may become hot during operation, or may be hot immediately after turning it off. Touching the mist for long periods of time or touching the diffuser unit may result in burns.

-4-

- Prohibited**  **Do not remove the outer cover while the product is in operation.**
→ Water or essential oil may spurt out, causing damage to the surrounding area or resulting in product malfunction.

- Required**  **Always use essential oils with this product, and follow the instructions below.**
→ This product is only to be used with the essential oils from 100% natural extracts. Never use synthetic perfumes or similar chemicals with this product. Never use more than seven to 10 drops (approx. 0.35 to 0.5ml) of essential oil per 350ml of water. Do not use essential oils excessively. The use of other substances may give rise to a toxic or fire risk.

- Prohibited**  **Never turn this product on when the water tank is empty.**
→ Doing so may result in damage to the ultrasonic diaphragm, malfunction, or leakage.

After Use

- Required**  **After use, dispose of any water left in the water tank.**
→ Failure to do so may result in malfunction or damage due to water freezing, or may lead to the growth of bacteria, etc.

- Prohibited**  **Do not block the mist diffuser outlet or the air intake located at the bottom of the product.**
→ Doing so may prevent proper function or result in damage, improper operation, excessive heat build up, or malfunction.

- Prohibited**  **Never attempt to refill this product during operation.**
→ Doing so may result in spurting out hot water or mist.

- Prohibited**  **Do not use this product continually for periods in excess of 180 minutes.**
→ Doing so may result in excessive heat in the ultrasonic diaphragm and product malfunction.

- Required**  **When not using this product for an extended period of time, unplug the AC adapter from the electrical outlet. When storing, follow the procedures detailed in Care/Storage, allow the product to dry, then place it in storage.**

-5-

About Essential Oils

- Always use essential oils from 100% natural plant extracts with this product. Perfumes, aroma oils containing synthetic perfumes, oils containing impurities or solids, etc. will result in product malfunction. Read and follow the cautions concerning the use of essential oils below.
- Use between seven to 10 drops (approx. 0.35 to 0.5 ml) of essential oil per 350ml of water (full tank). Adding essential oils to an empty (or low) water tank and excess amount of the oils may result in

product malfunction or improper operation allowing the oils to become adherent to the ultrasonic diaphragm.

- If you are concerned with lingering aroma when changing the type of essential oil, follow the procedures in Care/Storage to clean the water tank.
- Be careful not to allow essential oil to come into direct contact with the diffuser unit surfaces. Doing so may result in malfunction or may melt the product exterior,

Enjoying Your Aroma Diffuser

Operation Time

- **Maximum continuous operating time is three hours.**
** Mist volume may fluctuate and operating time may be shorter depending on water temperature, room temperature, and room humidity.*
(Recommended Usage Environment: Room temperature 15 to 25 °C, or 60 to 80°F, humidity 50%-60%)

Timer

- **Timer has four settings: 180 minutes, 120 minutes, 60 minutes, and 30 minutes.**
- **Product will automatically shut off at the end of the time set.**

LED Light

- **The LED light has two settings.**
Each press of the light switch cycles the light through high, low, and off settings.
- * When using with mist function, the LED light will shut off at the end of the timer or when the water tank becomes empty.

Other Functions

- **The outer cover is adjustable, and can be rotated to change to your favourite direction of the mist.**

-6-

Components

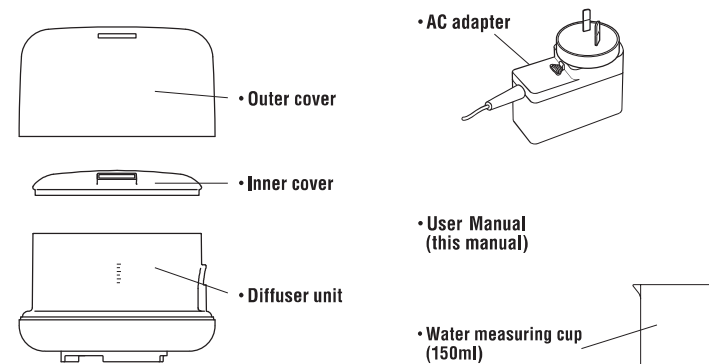

-7-

Part Names

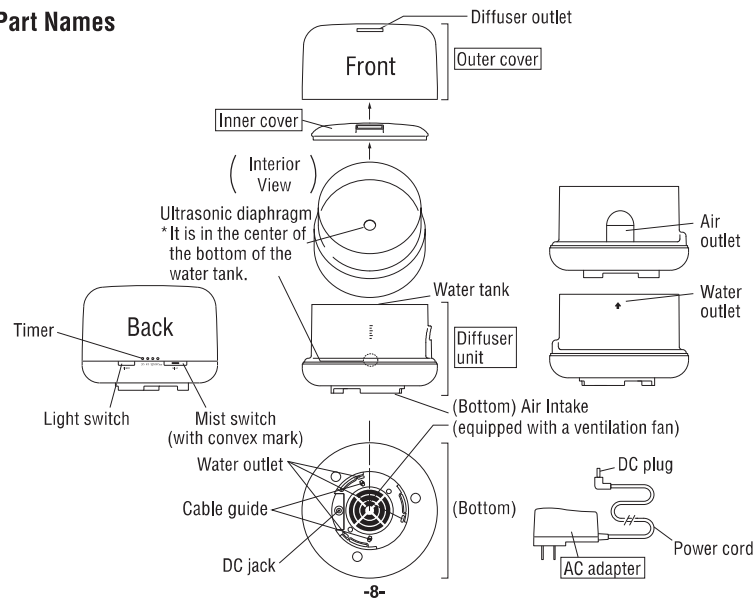

-8-

Directions for use

1. Unpack your aroma diffuser

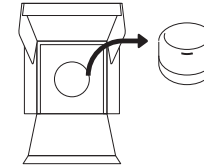

2. Remove stickers on the side of the aroma diffuser

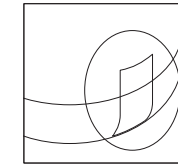

3. Remove the outer cover

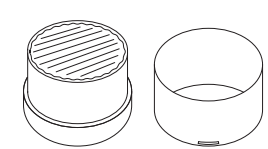

4. Take out the AC adapter, plug, and water measuring cup

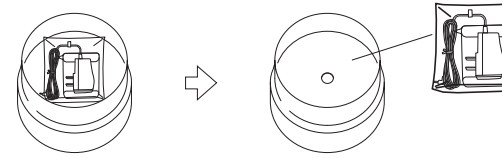

* Dispose of packaging materials in accordance with your local regulations.

-9-

5. Remove the outer cover



* Never touch the ultrasonic diaphragm inside the water tank directly. Doing so may result in malfunction or leakage.

6. Turn the diffuser unit over

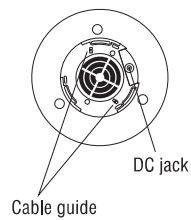

DC jack
Cable guide

7. Connect the power cord

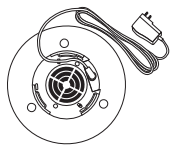

- Connect the included AC adapter to the DC jack on the bottom of the diffuser unit. Place the AC adapter cord through the either right or left side of the cable guide. Set the product on a stable, level surface.
- * Do not allow the diffuser unit to sit on the AC adapter cord.

-10-

8. Fill with tap water, add oil



- Be careful not to spill any water as you fill the water tank.
- Drip essential oil into the water tank.
- Always use the attached measuring cup (150ml) to fill the water tank.
- * Never attempt to pour water in through the diffuser outlet or fill the water tank directly from a tap. Doing so may result in product malfunction.
- * Fill the tank to between 100ml (minimum) and 350ml (maximum). Mist will not operate normally if the tank is not filled properly as indicated above.
- * Do not lean the diffuser unit at an angle when filled with water. Doing so may allow water to enter inside the unit through air outlet resulting in malfunction.
- * Standard for essential oil is between seven and 10 drops (approx. 0.35 to 0.5 ml) for 350ml of water (full tank).

9. Connect the AC adapter to the electrical outlet.

* Never turn this product on when the water tank is empty. Doing so may result in damage to the ultrasonic diaphragm, malfunction, or leak.

10. Replace the cover



- Confirm that the outer cover and inner cover are properly positioned.
- Place the outer cover over the inner cover.

- * The outer cover is not securely attached, so you may position the diffuser outlet to any direction you prefer.
- * Mist will not operate normally if the outer cover and inner cover are not aligned or there is a gap between the outer cover and the body of the diffuser unit.
- * When removing the outer cover while there is water in the water tank, always set the diffuser unit on a desk or similar surface. Do not tilt the diffuser at an angle.

-11-

11-1. Using Aroma

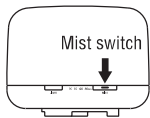

- ① Push the mist switch for at least two seconds. Mist will begin to emit from the diffuser.
- ② Push the mist switch again to change settings to 120 minutes, 60 minutes, 30 minutes, or off.
- ③ To stop the mist, either push the mist switch until it cycles to the off setting or hold down the mist switch for at least one second. (At any setting, holding the mist switch for one second or longer will make the diffuser beep and shut off the mist.)

- * The diffuser is off when first plugged in.
- * Pushing the mist switch when the water tank is empty (or low) will result in shutting off automatically after three beeps. (Alarm function of no water)
- * When water runs out during operation, the diffuser will beep three times and automatically shut off.
- * Due to water temperature and water quality conditions, etc., the diffuser is set to emit a smaller volume of mist when first turned on. The volume will gradually increase and stabilize.
- * If mist stops during operation, use a cotton swab or similar to clean the inner cover diffuser outlet and air intake.
- * Mist may not be visible depending on the temperature, humidity, or other surrounding factors. Even if the mist is difficult to see, there is no malfunction as long as mist is being generated within the water tank and the fan is operating (you can hear the fan motor).
- * Mist volume may increase during the summer or conditions with higher temperatures and humidity. In some circumstances, a water tank filled full (350ml) may empty prior to the completion of the 180-minute timer, shutting off the diffuser. This is not a malfunction. Mist volume may decrease during the winter or conditions with lower temperatures and humidity. Water may not be consumed as quickly as normal, but this is not a malfunction.
- * Mist may drop from the front of the diffuser outlet, causing condensation around the diffuser. In this case, place a towel or similar below the diffuser outlet to absorb moisture.

-12-

11-2. Using the Light

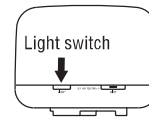

- ① Push the light switch. The light will turn on.
- ② Push the light switch again to cycle through Low and Off settings.

- * The LED light has two settings: High and Low.
- * The LED light will begin at the High setting.
- * At the end of a timed session, both the diffuser and the LED light will shut off.
- * The LED light will remain on, even when you manually cycle through settings to turn the diffuser off. Remember to turn the LED light off when not in use. Continue pushing the LED light switch to turn the light off. However, the LED light will also shut off when holding the mist switch down to turn off the diffuser.

-13-

Cleaning Up Spills

If a spill happens due to tipping over or tilting the diffuser unit while there is water in the water tank, water may enter the internal components of the diffuser, resulting in a malfunction.

If a spill happens, immediately perform the following procedures to drain the water inside.

1. Unplug the AC adapter from the electrical outlet

- * Be sure to unplug the AC adapter from the electrical outlet and turn off the diffuser before performing any procedures.
- * Never plug in/unplug the AC adapter with wet hands.

2. Remove the AC adapter plug from the DC jack

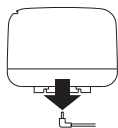

- After removing the AC adapter cord from the cable guide, remove the AC adapter plug from the DC jack.

3. Remove the outer cover



- * When removing/replacing the outer cover, always set the diffuser on a stable horizontal surface. Do not tilt the diffuser at an angle.
- * Water droplets will adhere to the inside of the outer cover. Accordingly, remove the outer cover in a location not susceptible to water damage. Set down a towel or similar to catch water droplets. Do not allow water to enter the air outlet.

-14-

4. Dispose of water in the water tank

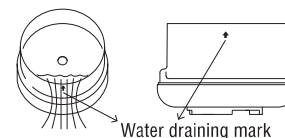

- Always tilt the diffuser unit in the direction of the water draining mark as indicated to pour out water remaining in the water tank.
- * Never tilt the diffuser toward the air outlet when pouring out water. If water enters through the air outlet, it may cause a malfunction.

5. Dry the Diffuser

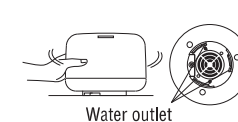

- Lightly shake the diffuser unit to allow water to pour out of the bottom water outlet. Allow the diffuser to dry thoroughly.
- * Allow 24 hours for the diffuser to dry.
- * Never use a hair dryer or similar to attempt to dry the diffuser. Allow the diffuser to air dry.

-15-

Care/Storage

For your safety, regularly perform care and maintenance for your Aroma Diffuser. Perform the following procedures. Perform these procedures every five to six uses or every two to three days as a rule.

1. Unplug the AC adapter from the electrical outlet

- * Always unplug the AC adapter from the electrical outlet and turn off the diffuser before performing any care or storage procedures.
- * Never plug in/unplug the AC adapter with wet hands.

3. Remove the outer cover



* When removing/replacing the outer cover, always set the diffuser on a stable horizontal surface. Do not tilt the diffuser unit at an angle.

- * Water droplets will adhere to the inside of the outer cover. Accordingly, remove the cover in a location not susceptible to water damage. Set down a towel or similar to catch water droplets. Do not allow water to enter the air outlet.

2. Remove the AC adapter plug from the DC jack

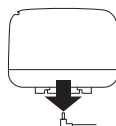

After removing the AC adapter cord from the cable guide, remove the AC adapter plug from the DC jack.

4. Dispose of water in the water tank

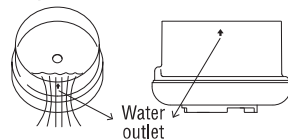

- Always tilt the diffuser unit in the direction of the water draining mark as indicated to pour out water remaining in the water tank.
- Never tilt the diffuser toward the air outlet when pouring out water. If water enters through the air outlet, it may cause a malfunction.

-16-

5. Clean the ultrasonic diaphragm and water tank

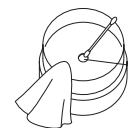

Ultrasonic diaphragm

- Wipe the water tank using a clean cloth dampened in a solution of warm water and neutral detergent; wring the cloth out well before use.
- Use a cotton swab or similar to clean the ultrasonic diaphragm located at the bottom of the water tank.
- After cleaning the tank and ultrasonic diaphragm, fill the tank with tap water and run the diffuser on a 30-minute timer.
- After the timer ends, pour out the water and wipe dry with a clean dry cloth.
- Never directly touch the ultrasonic diaphragm at the bottom of the water tank with your hand. Never subject the ultrasonic diaphragm to strong pressure.

- Any residual chlorine-based detergent, acidic detergent, or enzyme-based detergent in the diffuser may result in the formation of toxic gas. Accordingly, always use a neutral detergent.
- Always clean the interior of the water tank every two to three days. Ensure that water and parts are always kept clean. Using the diffuser without regular cleaning may result in water stains or mineral build up, resulting in degraded performance.
- Never use benzene, paint thinner, alcohol, or other chemicals to clean your diffuser. Such chemicals may damage parts, wear down graduation marks, etc.
- A dirty ultrasonic diaphragm may result in malfunction or improper operation. Periodically clean the ultrasonic diaphragm.

-17-

6. Clean the outer cover and inner cover

- If essential oil comes into contact with the outer cover or inner cover, or the covers become dirty, wipe it off with a clean cloth that is soaked in diluted neutral detergent in lukewarm water and wrung well.

- To remove dirt near the diffuser outlet, remove the inner cover for cleaning.
- Be sure the outer cover and inner cover are completely dry before use.

<How to Remove the Inner Cover>



Place finger here and gently pull.

<How to Replace the Inner Cover>

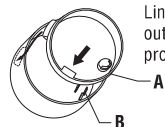

Line up the outer cover outlet and inner cover protrusion (A,B).

7. Clean the air intake filter

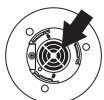

- Check the air intake at the bottom of the diffuser unit to see if any hair or dust has accumulated. If there is an accumulation, remove with a cotton swab or similar.
- The filter cover cannot be removed.

8. Storage

- Do not store this product in locations subject to high temperatures or humidity.
- Before using this product after a period of storage, clean the interior of the water tank using a neutral detergent.

-18-

Disposal

- Dispose of this product and packaging materials in accordance with your local regulations.

Troubleshooting

Check the followings when you wonder if the product is broken.

The product won't turn on, or it turns on for a short time, then turns off.

- Did you hold down the mist switch for two seconds or longer? (The mist switch is designed to hold down for several seconds to prevent erroneous operation.)
- Is there water in the water tank? Is the water level low?
→ Fill the tank to between 100ml (minimum) and 350ml (maximum). Pushing the mist switch when there is no water or when the water level is low will result in an electronic beep, after which the diffuser will shut off.
- Is the AC adapter correctly connected?
→ Check if the AC adapter is connected to the diffuser unit and the electrical outlet. To be sure, remove the DC plug from the diffuser unit and reinsert before checking operations.

No mist is emitted. Mist is not emitted well. Too much mist is emitted. It turns off sooner.

- Is the water level in the water tank low?
→ Fill the tank to between 100ml (minimum) and 350ml (maximum).
* Water level in the water tank will decrease the closer to the end of the timed session. Accordingly, mist volume may decrease; however, this is not a malfunction.
- Is there too much water in the water tank?
→ Mist will not operate normally if the tank is overfilled (more than 350ml).
- Is the ultrasonic diaphragm dirty?
→ Turn the power off, and then use a cotton swab or similar to gently clean any bubbles adhering to the ultrasonic diaphragm.

-19-

- Are there any bubbles accumulated on or around the ultrasonic diaphragm?
 - At low water temperatures, bubbles may accumulate on or around the ultrasonic diaphragm, preventing mist from emitting well.
 - Turn the power off, and then use a cotton swab or similar to gently clean any bubbles adhering to the ultrasonic diaphragm.
- Are the outer cover and inner cover correctly installed?
 - Ensure that the outer cover and inner cover are correctly in place.
 - When the outer cover and inner cover are misaligned, mist will not emit consistently from the diffuser outlet.
- Is the air intake at the bottom of the diffuser unit dirty?
 - Dust, etc. accumulated around the air intake at the bottom of the diffuser unit will reduce air flow and prevent mist output.
- Is the diffuser set in a location subject to high/low temperature and humidity?
 - <High temperature/humidity> Mist volume will increase. Even with a full water tank (350ml maximum), water may run out prior to the end of a 180-minute timed session. This is not a malfunction.
 - <Low temperature/humidity> Mist volume will decrease. Water may not be consumed as quickly as normal. This is not a malfunction.
 - * Mist may not be visible depending on the temperature, humidity, or other surrounding factors. Even if the mist is difficult to see, there is no malfunction as long as mist is being generated within the water tank and the fan is operating (you can hear the fan motor).

Water is leaking from the diffuser unit

- Is the outer cover installed correctly?
 - Is the inner cover misaligned or missing?
 - Ensure that the outer cover and inner cover are correctly in place.
 - If the outer cover and inner cover are misaligned, mist will not reach the diffuser outlet, and water will leak inside the diffuser unit.

-20-

Specifications

[Product Name]	ULTRASONIC AROMA DIFFUSER HAD-001-GLW-AU
[External Dimensions]	Approximately $\Phi 168 \times 121$ mm (height; not including protrusions)
[Diffuser Unit Weight]	Approximately 520g (not including AC adapter)
[Power Source]	Dedicated AC adapter Input: AC100—240V \sim 50/60Hz Output: DC24V \equiv 1000mA Power cord length: Approximately 170cm Power consumption: 32W
[Main Unit Power Consumption]	Approximately 18W
[Timer Settings]	180/120/60/30 (minutes)
[Aroma Diffusing Method]	Ultrasonic humidifier, vibrational frequency: Approximately 1.7MHz
[Water Tank Capacity]	Approximately 350ml
[No. of LEDs]	Lights: 12 Timer: 4 settings
[Main Materials]	Water tank, outer cover, inner cover bottom, measuring cup: polypropylene
[Accessories]	AC adapter Measuring cup, User Manual

-21-

Manufactured by:
RYOHIN KEIKAKU CO., LTD.
4-26-3 Higashi-ikebukuro, Toshima-ku, Tokyo JAPAN

Imported by:
AUSTRALIA MUJI RETAIL (AUSTRALIA) PTY LTD

Contact your retailer with any questions about this product.

Made in China

-22-

Quick Start Guide

These are brief instructions only. Be sure to read "Using Your Aroma Diffuser" in this User's Guide.

1. Remove the outer cover

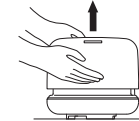

2. Fill with water and essential oil



- Be careful not to spill water while filling the water tank.
- Add a few drops of essential oil to the water in the water tank.



3-1. Mist Switch

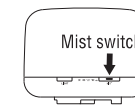

- Hold down the mist switch for two seconds or longer. Mist will begin to emit from the diffuser.
- Push the mist switch again to change settings to 120 minutes, 60 minutes, 30 minutes, or off.

3-2. Using the Light

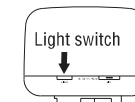

- Push the light switch. The light will turn on.
- Push the light switch again to cycle through Low and Off settings.

-23-